

INDUSTRIAL RELAYS

Industrial Electromagnetic Relays

Industrial electromagnetic relays are used mainly in industrial and power automation applications, in signaling controls, safety and protection systems and control and electric drives systems.



Features:

- DPDT, 3PDT and 4PDT contact configuration
- DC Coil voltages from 5VDC to 220V DC
- AC coil voltages from 6VAC to 240V AC 50/60 Hz
- Din Rail Plug in Socket are standard
- Rated load current: 5A/250V AC to 16A/250V AC rating
5A/24V DC to 16A/24VDC DC1 rating
- Test button with (K) or without block function (W)
- Built in LED light indicator (L)
- Surge suppression element with diode (D) or varistor (V)
- Approved for railroad applications (DE)
- Silver Nickel (AgNi) cadmium free contact material
- UL and CSA recognized relays
- ROHS2 and REACH compliance

Miniature Electromagnetic Relays

Miniature electromagnetic relays are used in many interface applications, standard automation projects, lighting control systems, emergency lighting applications, building application projects, food processing equipment control and many other electrical system applications.



Features:

- Standard SPDT, DPDT contact configuration
- DC Coil voltages from 3VDC to 110V DC
- AC coil voltages from 12VAC to 240V AC 50/60 Hz
- PCB mounting with socket or direct PCB solder
- Din Rail Plug in Socket are standard
- Rated load current: 8A/250V AC (DPDT) or 16A/250V AC (SPDT) rating;
8A/24V DC (DPDT) or 16A/24VDC (SPDT) DC1 rating
- Silver Nickel (AgNi) cadmium free contact material
- UL and CSA recognized relays
- ROHS2 and REACH compliance

Slimline Interface Relays

Slimline interface relays are used for PLC system and industrial automation applications, panel builders, machinery builders, time relays, office equipment and other applications that require a high switching capability in a small space.



Features:

- Standard SPDT contact configuration
- Standard 5 mm width
- DC Coil voltages from 5VDC to 60V DC
- Vertical or Horizontal configuration
- Sealed for Soldering and cleaning
- Can be used with Din rail socket or PCB mountable
- Rated load current
- 6A / 250V AC or 0.05A / 30V AC gold plated) rating
- 6A / 24V DC or 0.05A / 36V DC gold plated) rating
- 4A max for Solid state relays
- Silver Tin Oxide (AgSnO₂) cadmium free contact material
- Gold plated contact (AgSnO₂/Au 3μm) available
- UL recognized
- ROHS2 and REACH compliance

Subminiature Electromagnetic and Solid State Modules

Subminiature electromagnetic relays are used for PLC systems and industrial automation applications, panel builders, equipment builders and other applications that require a high switching capability in a small space. The Altech slim line interface relays can be used as a universal interface between the controller and the actuator to switch loads between 1 mA and 6A. They are available with electromechanical contacts or solid state configuration. Installation time is greatly reduced when a pre-assembled relays and sockets combination is used. Replacement relays and sockets are available from stock. Additional accessories include colored coded jumpers, spacers and markers (unmarked or marked based on the customer specification) for identification purposes.



Features:

- Standard SPDT contact configuration
- Space-saving 6.2 mm width
- Only 85 mm in height from DIN rail
- DC Coil voltages from 5VDC to 110V DC
- AC coil voltages from 6VAC to 240V AC 50/60 Hz
- Pre-assembled relay and DIN mount socket
- Screw clamp or Spring clamp terminals
- Universal AC/DC socket with built-in surge suppression and green LED
- Rated load current
- 6A / 250V AC or 0.05A / 30V AC gold plated) rating
- 6A / 24V DC or 0.05A / 36V DC gold plated) rating
- 4A max for Solid state relays
- Silver Tin Oxide (AgSnO₂) cadmium free contact material
- Gold plated contact (AgSnO₂/Au 3μm) available
- UL recognized
- ROHS2 and REACH compliance

Relays for Photovoltaic Systems

The Altech photovoltaic relays are suitable to be integrated in the solar converter to switch the DC voltage and current generated by the solar panels supplying the generated electricity to the electrical network. This requires an interface between the solar converter and the power grid. The circuit isolation gap between the converter and the power grid must have a contact gap of $\geq 1.5\text{mm}$ (according to safety standard DIN VDE 0126-1-1). Altech offers two different relays to meet this requirement.



Features:

- Standard DPST (2 NO) contact configuration
- DC Coil voltages from 5VDC to 110V DC
- Rated load current
- 35A / 250V AC or 48A / 250V AC
- 35A / 24V DC or 48A / 24V DC
- Contact gap $>1.75\text{ mm}$; Holding power 1W
- Silver Tin Oxide (AgSnO₂) cadmium free contact material
- Compact size, PCB mounting
- UL recognized
- ROHS2 and REACH compliance

MOUNTING OPTIONS					COIL			TYPE OF RELAY	NUMBER AND TYPE OF CONTACTS							RATED CURRENT [A]							
Direct PCB mounting	With plug-in socket PCB mounting	Panel mounting	35 mm rail mount acc. To PN-EN 60715	Others	AC	DC	AC/DC		SPDT	SPST(1NO)	SPST(1NC)	DPDT	DPST(2NO)	DPST(2NC)	3PDT	3PST(3NO)	4PDT	5	10	15	20	25	30

Industrial Electromagnetic Relays

					AC	DC	AC/DC	R2										12					
					AC	DC	AC/DC	R3										10					
					AC	DC	AC/DC	R4										6					
					AC	DC	AC/DC	RY2										12					
					AC	DC	AC/DC	R2M										5					
					AC	DC	AC/DC	RUC										16					
					AC	DC	AC/DC	R15 - DPDT										10					
					AC	DC	AC/DC	R15 - 3PDT										10					
					AC	DC	AC/DC	R15 - 4PDT										10					

Miniature Electromagnetic Relays

					AC	DC	AC/DC	RM40										5/8*					
					AC	DC	AC/DC	RM50										12					
					AC	DC	AC/DC	RM84										9					
					AC	DC	AC/DC	RM85										16					
					AC	DC	AC/DC	RM87										12					

Slimline Interface Relays

					AC	DC	AC/DC	RM699B										6					
					AC	DC	AC/DC	RSR30-...-D1-24-010-1										1					
					AC	DC	AC/DC	RSR30-...-A1-24-020-1										2					
					AC	DC	AC/DC	RSR30-...-D1-04-025-1										2.5					
					AC	DC	AC/DC	RSR30-...-D1-02-040-1										4					

Subminiature Electromagnetic and Solid State Modules

					AC	DC	AC/DC	PI6-1P										6					
					AC	DC	AC/DC	PI6-1T										1					
					AC	DC	AC/DC	PI6-1OC										1					
					AC	DC	AC/DC	PIR6W-1PS-...										max 6 ***					
					AC	DC	AC/DC	PIR6WB-1PS-... **										max 6 ***					

Relay Socket Combinations

					AC	DC	AC/DC	PI84 with socket GZT80										8					
					AC	DC	AC/DC	PI85 with socket GZT80										16					
					AC	DC	AC/DC	PI84 with socket GZM80										8					
					AC	DC	AC/DC	PI85 with socket GZM80										16					
					AC	DC	AC/DC	PIR2 with socket GZM2										12					
					AC	DC	AC/DC	PIR3 with socket GZM3										10					
					AC	DC	AC/DC	PIR4 with socket GZM4										6					
					AC	DC	AC/DC	PIR2M with socket GZ2										5					

* SPDT 5 A; SPST (1NO) 8A. **spring clamp socket. *** for more information see data sheet.

PI6-1P / PI6-1T / PI6-OC

Subminiature Electromagnetic and Solid State Modules

- Width 6,2 mm
- Interface relays PI6-1P - with SPDT contact output / PI6-1T with triac output
- 35 mm rail mount
- Maybe linked with interconnection strip type ZG20
- Equipped in green LED

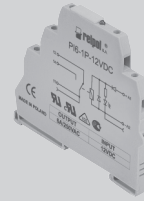
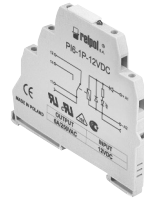

PI6-1P*

PI6-1T

PI6-OC

Contact data

Number and type of contacts	SPDT	SPST(1N0)	SPST(1N0)
Contact material	AgSnO ₂		
Max. switching voltage	400 V AC / 250 V DC	400 V / 440 V	70 V / 70 V
Min. switching voltage	10 V	20 V	5 V
Rated load	6 A / 250 V AC 6 A / 24 V DC; 0.15 A / 250 V DC	1.2 A / 400 V AC	0.5 A / 250 V DC
Min. switching current	100 mA	10 mA	
Max. inrush current	10 A 20 ms		
Max. non-repeat surge current		30 A ² t=20 ms	
Rated current	6A	1.2 A	0.5 A
Max. breaking capacity	1500 VA		
Min. breaking capacity	1 W		
Contact resistance	≤ 100 mΩ 100 mA. 24 V		
I ² t for fusing		5.1 A ² s t=1-10 ms	
dI/dt		50 A/μs	
dV/dt		40 V/μs	
Max. operating frequency			
• at rated load	AC1		
• no load	360 cycles/hour 72 000 cycles/hour		

Input circuit

Rated voltage	DC AC: 50/60 Hz AC/DC	12 ... 36 V 24 ... 230 V	5...32 V 24 ... 230 V	5...32 V 24 ... 230 V
Turn-off voltage			AC: ≥ 0.2 U _N ; DC: ≥ 0.1 U _N	AC : ≥ 0.2 U _N ; DC: ≥ 0.1 U _N
Must release voltage		AC: ≥ 0.2 U _N ; DC: ≥ 0.1 U _N		
Operating range of supply voltage		see page 91		
Must operate voltage		AC and DC: ≤ 0.8 U _N		
Rated power consumption	DC AC/DC AC/DC	0.3 ... 0.7 W 0.3 ... 1.6 VA / 0.3 ... 1.6 W	0.3 W; 5...32 V DC at 24 V 0.3 VA / 0.3 W; 24 V AC/DC 1.6 VA / 1.6 W; 230 V AC/DC	0.3 W; 5...32 V DC at 24 V 0.3 VA / 0.3 W; 24 V AC/DC 1.0 VA / 1.0 W; 230 V AC/DC

Insulation

Insulation rated voltage	400 V AC	600 V AC	600 V AC
Rated surge voltage	4 000 V 1.2 / 50 μs		
Overtoltage category	III		
Insulation pollution degree	3	2	2
Dielectric strength	4000 V AC 50/60 Hz. 1 min. type of insulation: reinforced	4000 V AC 50/60 Hz. 1 min. type of insulation: reinforced	3000 V AC 50/60 Hz. 1 min. type of insulation: reinforced
• input - output	6000 V 1.2 / 50 μs		
• input - output	2500 V AC 50/60 Hz. 1 min.		
• mass - input. output	1000 V AC 50/60 Hz. 1 min.		
• contact clearance	type of clearance: micro-disconnection		
Input - output distance	≥ 6 mm / ≥ 8 mm		
• clearance / creepage			

General data

Operating time (typical value)	AC: 7 ms; DC: 6 ms	10 ms max. (zero turn-on)	
Release time (typical value)	AC: 15 ms; DC: 10 ms	10 ms max.	
Electrical life	> 0.6 x 10 ⁵ ; 6 A. 250 V AC > 2 x 10 ⁵ ; 2 A. 250 V AC 10 ⁵ ; 6 A. 30 V DC		
• resistive AC1			
• cos φ = 0.4			
• resistive DC1			
Mechanical life (cycles)	> 2 x 10 ⁷		
Max. switching frequency			10 kHz 5...32 V DC (for load up to 24 V DC: 15 kHz)
Dimensions (L x W x H)	93.8 x 6.2 x 80 mm	93.8 x 6.2 x 80 mm	93.8 x 6.2 x 80 mm
Weight	40 g	40 g	40g
Ambient temperature			
• storage	-40...+70 °C	-40...+70 °C	-40...+70 °C
• operating	AC: -40...+55 °C; DC (12. 24 V): -40...+60 °C	-40...+55 °C	-40...+55 °C
Protection category	IP 20 PN-EN 60529	IP 20 PN-EN 60529	IP 20 PN-EN 60529
Environmental protection	RTI PN-EN 116000-3	RTI PN-EN 116000-3	RTI PN-EN 116000-3

* UL Recognized

PI6-1P / PI6-1T / PI6-OC

Subminiature Electromagnetic and Solid State Modules



PI6-1P



CONNECTION DIAGRAMS

PI6-1P-12VDC, PI6-1P-12VDC-01
 PI6-1P-24VDC, PI6-1P-24VDC-01
 PI6-1P-36VDC, PI6-1P-36VDC-01

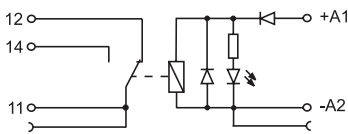

PI6-1P-115VAC/DC
 PI6-1P-230VAC/DC, PI6-1P-230VAC/DC-01

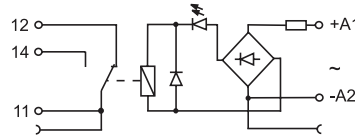

PI6-1P-24VAC/DC, PI6-1P-24VAC/DC-01
 PI6-1P-42VAC/DC

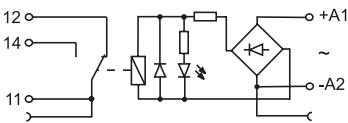

PI6-1P-230VAC/DC-10

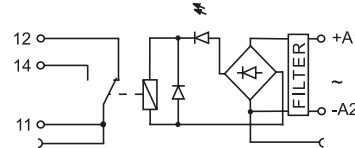

DIMENSIONS

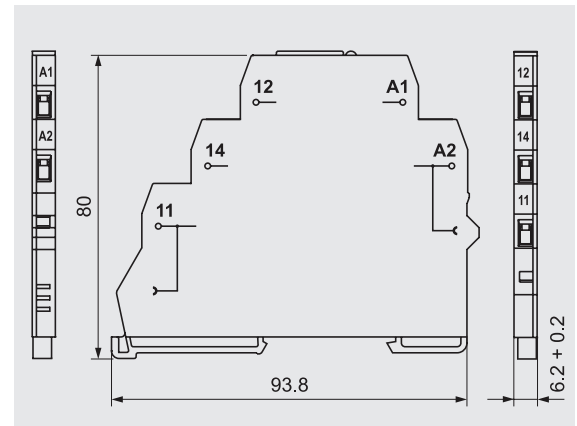

PI6-1P SPDT AC 50/60Hz & DC coil

Part Number	Rated input voltage Un	Power of input circuit	Input voltage range in V	
			min. (at 20°C)	max. (at 55°C)
PI6-1P-12VDC	12 V DC	0.3 W	9.6	14.1
PI6-1P-24VDC	24 V DC	0.4 W	19.2	28.0
PI6-1P-36VDC	36 V DC	0.7 W	28.8	40.0
PI6-1P-24VAC/DC	24 V AC/DC	0.5 VA / 0.5 W	19.2	26.4
PI6-1P-42VAC/DC	42 V AC/DC	0.3 VA / 0.3 W	33.6	50.0
PI6-1P-115VAC/DC	115 V AC/DC	0.8 VA / 0.8 W	92.0	130.0
PI6-1P-230VAC/DC	230 V AC/DC	0.8 VA / 0.8 W	184.0	253.0

► **BOLD** - Regular stocked items.

PI6-1P / PI6-1T / PI6-OC

Subminiature Electromagnetic and Solid State Modules



PI6-1T



CONNECTION DIAGRAMS

PI6-1T-5...32VDC

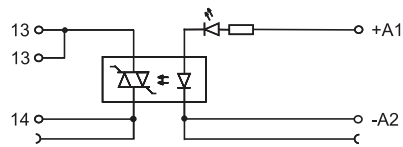

PI6-1T-24VAC/DC
PI6-1T-230VAC/DC

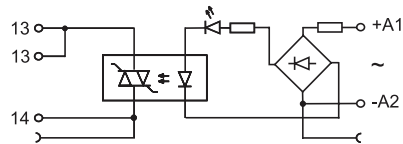

DIMENSIONS

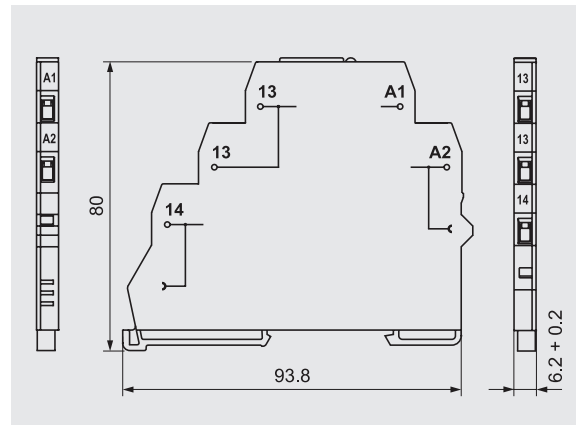

PI6-1T SPST(1NO) AC 50/60Hz & DC coil

Part Number	Rated input voltage Un	Power of input circuit
PI6-1T-5...32VDC	5...32 V DC	0.3 W at 24V
PI6-1T-24VAC/DC	24 V AC/DC	0.3 VA / 0.3 W
PI6-1T-230VAC/DC	230 V AC/DC	1.6 VA / 1.6 W

► **BOLD** - Regular stocked items.

PI6-1P / PI6-1T / PI6-OC

Subminiature Electromagnetic and Solid State Modules



PI6-OC



CONNECTION DIAGRAMS

PI6-OC-5...32VDC

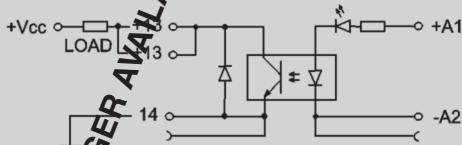

PI6-OC-24VAC/DC PI6-OC-230VAC/DC

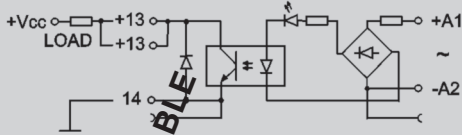

DIMENSIONS

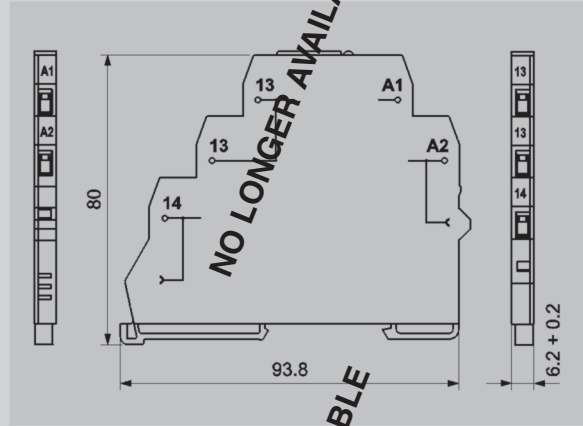

PI6-OC SPST(1NO) AC 50/60Hz & DC coil

Part Number	Rated input Voltage Un	Power of input circuit
PI6-OC-5...32VDC	5...32 V DC	0.3 W at 24V
PI6-OC-24VAC/DC	24 V AC/DC	0.3 VA / 0.3 W
PI6-OC-230VAC/DC	230 V AC/DC	1.0 VA / 1.0 W

► BOLD - Regular stocked items.

PIR6W-1PS

Subminiature Electromagnetic and Solid State Modules

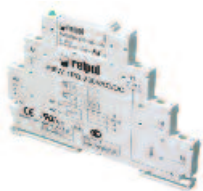

- Screw Clamp Terminals
- Electronic screw terminals socket (PI6W-1PS)
- Electromagnetic relay (RM699BV) or solid state relay (RSR30)
- Width 6.2 mm
- Equipped with green LED



PIR6W-1PS

Electromagnetic Relay (RM699BV) contact information

Number and type of contacts (code of output)	SPDT (R)	SPDT (R-01)
Contact material	AgSnO ₂	AgSnO ₂ / Au3μm
Max. switching voltage	400 V AC / 250 V DC	30 V AC / 36 V DC
Min. switching voltage	10 V	5 V
Rated load	6 A / 250 V AC	0.05 A / 30 V AC
	6 A / 24 V DC; 0.15 A / 250 V DC	0.05 A / 36 V DC
Min. switching current	100 mA	10 mA
Max. inrush current	10 A 20 ms	0.1 A 20 ms
Rated current	6A	0.05A
Max. / Min. breaking capacity	1500 VA / 1 W	1.2 VA / 0.05 W
Contact resistance	≤ 100 mΩ 100 mA 24 V	≤ 30 mΩ 10 mA 5 V
Max. operating frequency	360 cycles/hour	360 cycles/hour
• at rated load	72 000 cycles/hour	72 000 cycles/hour
• no load		

Solid State (RSR30) output information

Type of output (code of output)	Triac (T) max. 2 A	Transistor (C) max. 1 A	Transistor (O) max. 2 A
Number and type of outputs	SPST (1 NO)	SPST (1 NO)	SPST (1 NO)
Rated voltage	240 V AC	48 V DC	24 V DC
Max. / Min. output voltage	280 V AC / 12 V AC	60 V DC / 1.5 V DC	32 V DC / 1.5 V DC
Rated continuous output current	1A	1A	2A
Min. making capacity current	50 mA	1 mA	1 mA
Max. off-state leakage current (rest condition)	1.5 mA	1 mA	1 mA
Max. on-state voltage drop on the connection (operating state)	1.2 V	0.4 V	0.24 V
Operating switching frequency		10 Hz	10 Hz

Input Circuit

Rated voltage	DC AC: 50/60 Hz AC/DC	6 ... 60 V 24 ... 230 V
Must release voltage		AC: ≥ 0.2 U _n ; DC: ≥ 0.1 U _n
Operating range of supply voltage		0.8...1.2 U _n ; 0.85...1.2 U _n 6 V DC
Must operate voltage		≤ 0.8 U _n ; ≤ 0.85 U _n 6 V DC
Rated power consumption	DC AC/DC	0.2 ... 0.5 W 0.5 ... 1.2 VA / 0.4 ... 1.2 W

Insulation

Insulation rated voltage	250 V AC
Rated surge voltage	4000 V 1.2 / 50 μs
Overvoltage category	III
Insulation pollution degree	3
Dielectric strength: input - output	4000 V AC 50/60 Hz. 1 min.. type of insulation: reinforced
Dielectric strength: input - output	6000 V 1.2 / 50 μs
Dielectric strength: mass - input output	2500 V AC 50/60 Hz. 1 min.
Dielectric strength: contact clearance	1000 V AC 50/60 Hz. 1 min.. output R and R-01
Input - output distance: clearance / creepage	≥ 6 mm / ≥ 8 mm
Mass - input. output distance: clearance / creepage	≥ 3 mm / ≥ 3.6 mm

General data

Operating time (typical value)	PIR6W-1PS-...-R/-R01: DC: 8 ms AC/DC: 20 ms
	PIR6W-1PS-...-T: DC: 100 μs AC/DC: 10 ms
	PIR6W-1PS-...-C/-O: DC: 50 μs AC/DC: 10 ms
Release time (typical value)	PIR6W-1PS-...-R/-R01: DC: 10 ms AC/DC: 25 ms
	PIR6W-1PS-...-T: DC: 1/2 cycle + 1 ms AC/DC: 30 ms
	PIR6W-1PS-...-C/-O: DC: 600 μs AC/DC: 20 ms
Electrical life (resistive AC1)	PIR6W-1PS-...-R: > 0.5 x 10 ⁶ 6 A 250 V AC
Mechanical life (cycles)	PIR6W-1PS-...-R/-R01: > 10 ⁷
Dimensions (L x W x H)	98.5 x 6.2 x 85.5 mm
Weight	45 g
Ambient temperature: storage	PIR6W-1PS-...-R/-R01-T: -40...+70 °C ...-C/-O: -25...+70 °C
Ambient temperature: operating	PIR6W-1PS-...-R/-R01: -40...+55 °C ...-T/-C/-O: -20...+55 °C
	PIR6W-1PS-230VAC/DC-R: -40...+50 °C ...-C/-O: -20...+50 °C
Protection category	IP 20 PN-EN 60529
Environmental protection	RTI PN-EN 116000-3
Shock resistance	10 g
Vibration resistance	5 g 10...500 Hz

T - triac; C - transistor; O - transistor.

PIR6W-1PS

Subminiature Electromagnetic and Solid State Modules

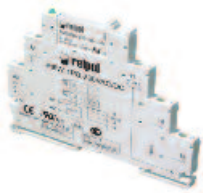

PIR6W-1PS



CONNECTION DIAGRAMS

PIR6W-1PS-...-R, PIR6W-1PS-...-R01

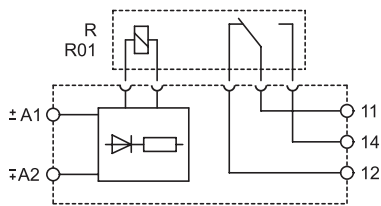

PIR6W-1PS-...-T, PIR6W-1PS-...-C, PIR6W-1PS-...-O

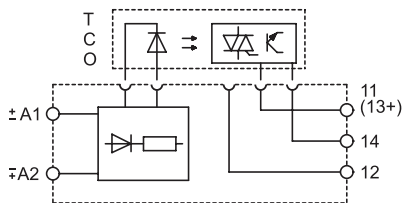

DIMENSIONS

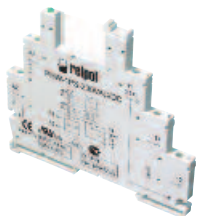
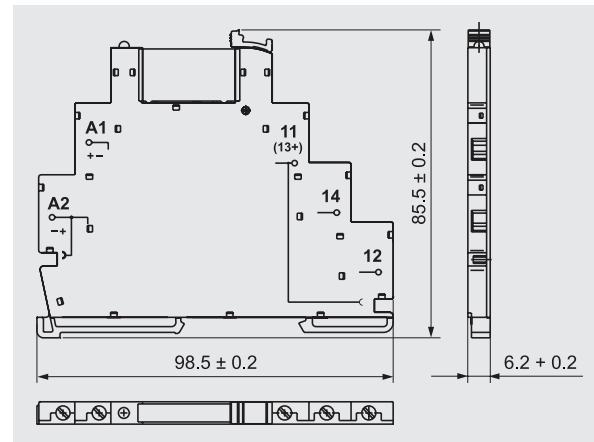

PI6W-1P-...



RM699BV



RSR30

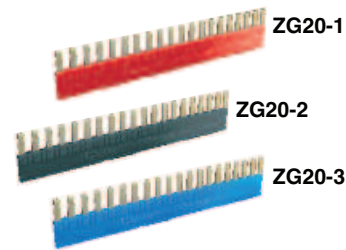

PI6W-1246



Green LED:
signalling the operation status of the relay.

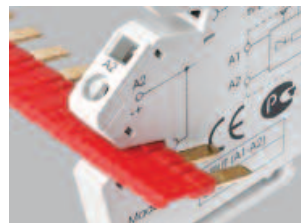

Interconnection strip ZG20:
bridging of common input or output signals.



Movable ejector: protection and easy replacement of the operational relay.

All accessories are sold separately.

PIR6W-1PS

Subminiature Electromagnetic and Solid State Modules

Electromagnetic Relays

Featuring **Electromagnetic relay RM699BV / 6A; 250VAC / 24VDC**

Part Number	Rated input voltage U_n	Power of input circuit	Socket code	*Operational relay code	Rated voltage of operational relay U_s
PIR6W-1PS-6VDC-R	6 V DC	0.3 W	PI6W-1PS-6VDC	RM699BV-3011-85-1005	5 V DC
PIR6W-1PS-12VDC-R	12 V DC	0.2 W	PI6W-1PS-12/24VDC	RM699BV-3011-85-1012	12 V DC
▶ PIR6W-1PS-24VDC-R	24 V DC	0.3 W	PI6W-1PS-12/24VDC	RM699BV-3011-85-1024	24 V DC
PIR6W-1PS-36VDC-R	36 V DC	0.3 W	PI6W-1PS-36VDC	RM699BV-3011-85-1024	24 V DC
PIR6W-1PS-48VDC-R	48 V DC	0.4 W	PI6W-1PS-48VDC	RM699BV-3011-85-1024	24 V DC
PIR6W-1PS-60VDC-R	60 V DC	0.5 W	PI6W-1PS-60VDC	RM699BV-3011-85-1024	24 V DC
▶ PIR6W-1PS-24VAC/DC-R	24 V AC/DC	0.5 VA / 0.4 W	PI6W-1PS-24VAC/DC	RM699BV-3011-85-1012	12 V DC
PIR6W-1PS-42VAC/DC-R	42 V AC/DC	0.5 VA / 0.4 W	PI6W-1PS-42VAC/DC	RM699BV-3011-85-1024	24 V DC
▶ PIR6W-1PS-115VAC/DC-R	115 V AC/DC	1.2 VA / 1.2 W	PI6W-1PS-115VAC/DC	RM699BV-3011-85-1024	24 V DC
PIR6W-1PS-230VAC/DC-R	230 V AC/DC	1.2 VA / 1.2 W	PI6W-1PS-230VAC/DC	RM699BV-3011-85-1048	48 V DC

Featuring **Electromagnetic relay RM699BV / 6A; 250VAC / 24VDC universal input**

Part Number	Rated input voltage U_n	Power of input circuit	Socket code	*Operational relay code	Rated voltage of operational relay U_s
▶ PIR6W-1P-12U	12 V DC	0.3 W	PI6W-1P-12VDC	RM699BV-3011-85-1012	12 V DC
▶ PIR6W-1P-24U	24 V AC/DC	0.3 VA / 0.3 W	PI6W-1P-24VAC/DC	RM699BV-3011-85-1024	24 V DC
▶ PIR6W-1P-115U	115 V AC/DC	0.9 VA / 0.9 W	PI6W-1P-115VAC/DC	RM699BV-3011-85-1024	24 V DC
▶ PIR6W-1P-230V AC/DC	230 V AC/DC	0.8 VA / 0.8 W	PI6W-1P-230VAC/DC	RM699BV-3011-85-1060	60 V DC

Featuring **Electromagnetic relay RM699BV / 0.05A; 30VAC / 36VDC. gold plated contacts**

Part Number	Rated input voltage U_n	Power of input circuit	Socket code	*Operational relay code	Rated voltage of operational relay U_s
PIR6W-1PS-6VDC-R01	6 V DC	0.3 W	PI6W-1PS-6VDC	RM699BV-3011-85-1005	5 V DC
PIR6W-1PS-12VDC-R01	12 V DC	0.2 W	PI6W-1PS-12/24VDC	RM699BV-3011-85-1012	12 V DC
PIR6W-1PS-24VDC-R01	24 V DC	0.3 W	PI6W-1PS-12/24VDC	RM699BV-3011-85-1024	24 V DC
PIR6W-1PS-36VDC-R01	36 V DC	0.3 W	PI6W-1PS-36VDC	RM699BV-3011-85-1024	24 V DC
PIR6W-1PS-48VDC-R01	48 V DC	0.4 W	PI6W-1PS-48VDC	RM699BV-3011-85-1024	24 V DC
PIR6W-1PS-60VDC-R01	60 V DC	0.5 W	PI6W-1PS-60VDC	RM699BV-3011-85-1024	24 V DC
▶ PIR6W-1PS-24VAC/DC-R01	24 V AC/DC	0.5 VA / 0.4 W	PI6W-1PS-24VAC/DC	RM699BV-3011-85-1012	12 V DC
PIR6W-1PS-42VAC/DC-R01	42 V AC/DC	0.5 VA / 0.4 W	PI6W-1PS-42VAC/DC	RM699BV-3011-85-1024	24 V DC
PIR6W-1PS-115VAC/DC-R01	115 V AC/DC	1.2 VA / 1.2 W	PI6W-1PS-115VAC/DC	RM699BV-3011-85-1024	24 V DC
PIR6W-1PS-230VAC/DC-R01	230 V AC/DC	1.2 VA / 1.2 W	PI6W-1PS-230VAC/DC	RM699BV-3011-85-1048	48 V DC

* It should be noted that the rated input voltage of the operational relay (U_s) is not always the same as the rated input voltage of the relay and socket combination (U_n) (This is important when ordering operational relays for sockets).

Altech Custom Assemblies

Altech provides quick turnaround and competitive prices on assemblies.

For complete assemblies contact Altech.

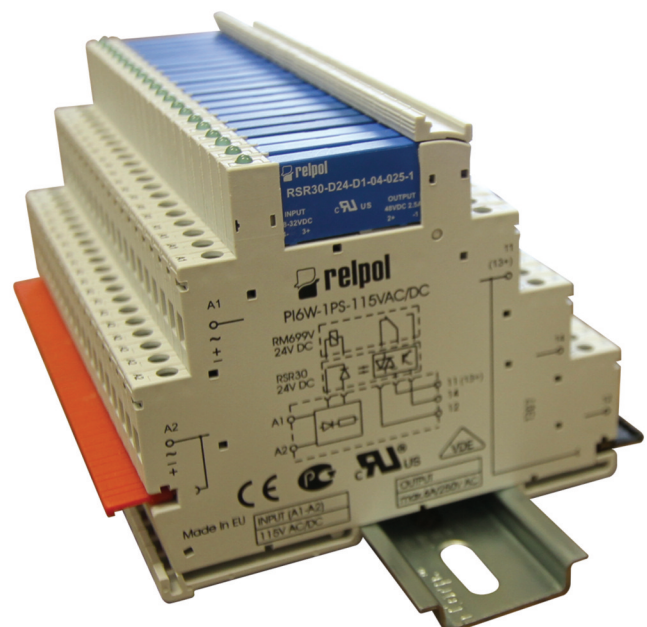

▶ **BOLD** - Regular stocked items.

Solid State Relays

Featuring Solid State Triac (T) relay RSR30 / 2A; 240VAC output

Part Number	Rated input voltage U_N	Power of input circuit	Socket code	Operational relay code	Rated voltage of operational relay U_S
PIR6W-1PS-6VDC-T	6 V DC	0.2 W	PI6W-1PS-6VDC	RSR30-D05-A1-24-020-1	5 V DC
PIR6W-1PS-12VDC-T	12 V DC	0.2 W	PI6W-1PS-12/24VDC	RSR30-D12-A1-24-020-1	12 V DC
PIR6W-1PS-24VDC-T	24 V DC	0.3 W	PI6W-1PS-12/24VDC	RSR30-D24-A1-24-020-1	24 V DC
PIR6W-1PS-36VDC-T	36 V DC	0.3 W	PI6W-1PS-36VDC	RSR30-D24-A1-24-020-1	24 V DC
PIR6W-1PS-48VDC-T	48 V DC	0.4 W	PI6W-1PS-48VDC	RSR30-D24-A1-24-020-1	24 V DC
PIR6W-1PS-60VDC-T	60 V DC	0.5 W	PI6W-1PS-60VDC	RSR30-D24-A1-24-020-1	24 V DC
► PIR6W-1PS-24VAC/DC-T	24 V AC/DC	0.5 VA / 0.4 W	PI6W-1PS-24VAC/DC	RSR30-D12-A1-24-020-1	12 V DC
PIR6W-1PS-42VAC/DC-T	42 V AC/DC	0.5 VA / 0.4 W	PI6W-1PS-42VAC/DC	RSR30-D24-A1-24-020-1	24 V DC
PIR6W-1PS-115VAC/DC-T	115 V AC/DC	1.0 VA / 1.0 W	PI6W-1PS-115VAC/DC	RSR30-D24-A1-24-020-1	24 V DC

Featuring Solid State Transistor (C) relay RSR30 / 1A; 48VDC output

Part Number	Rated input voltage U_N	Power of input circuit	Socket code	Operational relay code	Rated voltage of operational relay U_S
PIR6W-1PS-6VDC-C	6 V DC	0.2 W	PI6W-1PS-6VDC	RSR30-D05-D1-04-025-1	5 V DC
PIR6W-1PS-12VDC-C	12 V DC	0.2 W	PI6W-1PS-12/24VDC	RSR30-D12-D1-04-025-1	12 V DC
PIR6W-1PS-24VDC-C	24 V DC	0.3 W	PI6W-1PS-12/24VDC	RSR30-D24-D1-04-025-1	24 V DC
PIR6W-1PS-36VDC-C	36 V DC	0.3 W	PI6W-1PS-36VDC	RSR30-D24-D1-04-025-1	24 V DC
PIR6W-1PS-48VDC-C	48 V DC	0.4 W	PI6W-1PS-48VDC	RSR30-D24-D1-04-025-1	24 V DC
PIR6W-1PS-60VDC-C	60 V DC	0.5 W	PI6W-1PS-60VDC	RSR30-D24-D1-04-025-1	24 V DC
► PIR6W-1PS-24VAC/DC-C	24 V AC/DC	0.5 VA / 0.4 W	PI6W-1PS-24VAC/DC	RSR30-D12-D1-04-025-1	12 V DC
PIR6W-1PS-42VAC/DC-C	42 V AC/DC	0.5 VA / 0.4 W	PI6W-1PS-42VAC/DC	RSR30-D24-D1-04-025-1	24 V DC
PIR6W-1PS-115VAC/DC-C	115 V AC/DC	1.0 VA / 1.0 W	PI6W-1PS-115VAC/DC	RSR30-D24-D1-04-025-1	24 V DC
PIR6W-1PS-230VAC/DC-C	230 V AC/DC	1.0 VA / 1.0 W	PI6W-1PS-230VAC/DC	RSR30-D48-D1-04-025-1	48 V DC

Featuring Solid State Transistor (O) relay RSR30 / 2A; 24VDC output

Part Number	Rated input voltage U_N	Power of input circuit	Socket code	Operational relay code	Rated voltage of operational relay U_S
PIR6W-1PS-6VDC-O	6 V DC	0.2 W	PI6W-1PS-6VDC	RSR30-D05-D1-02-040-1	5 V DC
PIR6W-1PS-12VDC-O	12 V DC	0.2 W	PI6W-1PS-12/24VDC	RSR30-D12-D1-02-040-1	12 V DC
PIR6W-1PS-24VDC-O	24 V DC	0.3 W	PI6W-1PS-12/24VDC	RSR30-D24-D1-02-040-1	24 V DC
PIR6W-1PS-36VDC-O	36 V DC	0.3 W	PI6W-1PS-36VDC	RSR30-D24-D1-02-040-1	24 V DC
PIR6W-1PS-48VDC-O	48 V DC	0.4 W	PI6W-1PS-48VDC	RSR30-D24-D1-02-040-1	24 V DC
PIR6W-1PS-60VDC-O	60 V DC	0.5 W	PI6W-1PS-60VDC	RSR30-D24-D1-02-040-1	24 V DC
► PIR6W-1PS-24VAC/DC-O	24 V AC/DC	0.5 VA / 0.4 W	PI6W-1PS-24VAC/DC	RSR30-D12-D1-02-040-1	12 V DC
PIR6W-1PS-42VAC/DC-O	42 V AC/DC	0.5 VA / 0.4 W	PI6W-1PS-42VAC/DC	RSR30-D24-D1-02-040-1	24 V DC
PIR6W-1PS-115VAC/DC-O	115 V AC/DC	1.0 VA / 1.0 W	PI6W-1PS-115VAC/DC	RSR30-D24-D1-02-040-1	24 V DC
PIR6W-1PS-230VAC/DC-O	230 V AC/DC	1.0 VA / 1.0 W	PI6W-1PS-230VAC/DC	RSR30-D48-D1-02-040-1	48 V DC

It should be noted that the rated input voltage of the operational relay (U_S) is not always the same as the rated input voltage of the relay and socket combination (U_N) (This is important when ordering operational relays for sockets).

► **BOLD** - Regular stocked items.

PIR6WB-1PS

Subminiature Electromagnetic and Solid State Modules



- Spring Clamp Terminals
- Electronic **spring** terminals socket (PI6W-1PS)
- Electromagnetic relay (RM699BV) or solid state relay (RSR30)
- Width 6.2 mm
- Equipped with green LED



PIR6WB-1PS

Electromagnetic Relay (RM699BV)

contact information

Number and type of contacts (code of output)		SPDT (R)	SPDT (R-01)
Contact material		AgSnO ₂	AgSnO ₂ / Au3µm
Max. switching voltage		400 V AC / 250 V DC	30 V AC / 36 V DC
Min. switching voltage	AC / DC	10 V	5 V
Rated load	AC1 DC1	6 A / 250 V AC 6 A / 24 V DC; 0.15 A / 250 V DC	0.05 A / 30 V AC 0.05 A / 36 V DC
Min. switching current		100 mA	10 mA
Max. inrush current		10 A 20 ms	0.1 A 20 ms
Rated current		6A	0.05A
Max. / Min. breaking capacity	AC1	1500 VA / 1 W	1.2 VA / 0.05 W
Contact resistance		≤ 100 mΩ 100 mA, 24 V	≤ 30 mΩ 10 mA, 5 V
Max. operating frequency	AC1	360 cycles/hour	360 cycles/hour
• at rated load			
• no load		72 000 cycles/hour	72 000 cycles/hour

Solid State (RSR30)

output information

Type of output (code of output)	Triac (T) max. 2 A	Transistor (C) max. 1 A	Transistor (O) max. 2 A
Number and type of outputs	SPST (1 NO)	SPST (1 NO)	SPST (1 NO)
Rated voltage	240 V AC	48 V DC	24 V DC
Max./ Min. output voltage	280 V AC / 12 V AC	60 V DC / 1,5 V DC	32 V DC / 1,5 V DC
Rated continuous output current	1A	1A	2A
Min. making capacity current	50 mA	1 mA	1 mA
Max. off-state leakage current (rest condition)	1,5 mA	1 mA	1 mA
Max. on-state voltage drop on the connection (operating state)	1,2 V	0,4 V	0,24 V
Operating switching frequency		10 Hz	10 Hz

Input Circuit

Rated voltage	DC	6 ... 60 V
	AC: 50/60 Hz AC/DC	24 ... 230 V
Must release voltage		AC: ≥ 0.2 U _n ; DC: ≥ 0.1 U _n
Operating range of supply voltage		0.8...1.2 U _n ; 0.85...1.2 U _n 6 V DC
Must operate voltage		≤ 0.8 U _n ; ≤ 0.85 U _n 6 V DC
Rated power consumption	DC AC/DC	0.2 ... 0.5 W 0.5 ... 1.2 VA / 0.4 ... 1.2 W

Insulation

Insulation rated voltage	250 V AC
Rated surge voltage	4000 V 1.2 / 50 µs
Overvoltage category	III
Insulation pollution degree	3
Dielectric strength: input - output	4000 V AC 50/60 Hz, 1 min., type of insulation: reinforced
Dielectric strength: input - output	6000 V 1.2 / 50 µs
Dielectric strength: contact clearance	1000 V AC 50/60 Hz, 1 min., output R and R-01
Input - output distance: clearance / creepage	≥ 6 mm / ≥ 8 mm

General data

Operating time (typical value)	PIR6W-1PS-...-R/-R01: DC: 8 ms AC/DC: 20 ms
	PIR6W-1PS-...-T: DC: 100 µs AC/DC: 10 ms
	PIR6W-1PS-...-C/-O: DC: 50 µs AC/DC: 10 ms
Release time (typical value)	PIR6W-1PS-...-R/-R01: DC: 10 ms AC/DC: 25 ms
	PIR6W-1PS-...-T: DC: 1/2 cycle + 1 ms AC/DC: 30 ms
	PIR6W-1PS-...-C/-O: DC: 600 µs AC/DC: 20 ms
Electrical life (resistive AC1)	PIR6W-1PS-...-R: > 0.5 x 10 ⁶ 6 A, 250 V AC
Mechanical life (cycles)	PIR6W-1PS-...-R/-R01: > 10 ⁷
Dimensions (L x W x H)	98.5 x 6.2 x 84.6 mm
Weight	55 g
Ambient temperature: storage	PIR6W-1PS-...-R/-R01-T: -40...+70 °C ...-C/-O: -25...+70 °C
Ambient temperature: operating	PIR6W-1PS-...-R/-R01: -40...+55 °C ...-T/-C/-O: -20...+55 °C
Protection category	IP 20 PN-EN 60529
Environmental protection	RTI PN-EN 116000-3
Shock resistance	10 g
Vibration resistance	5 g 10...500 Hz

T - triac; C - transistor; O - transistor.

PIR6WB-1PS

Subminiature Electromagnetic and Solid State Modules



PIR6WB-1PS



CONNECTION DIAGRAMS

PIR6WB-1PS-...-R, PIR6WB-1PS-...-R01

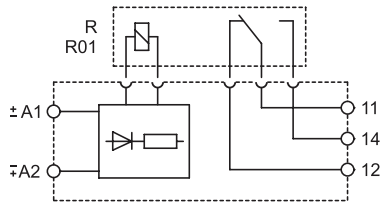

PIR6WB-1P-230VAC/DC-10

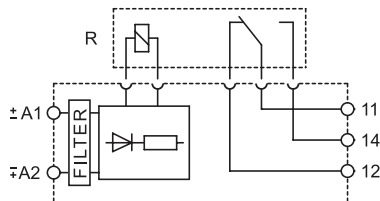

PIR6WB-1PS-...-T, PIR6WB-1PS-...-C, PIR6WB-1PS-...-O

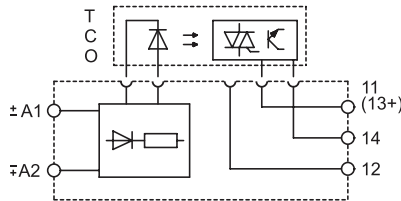

DIMENSIONS

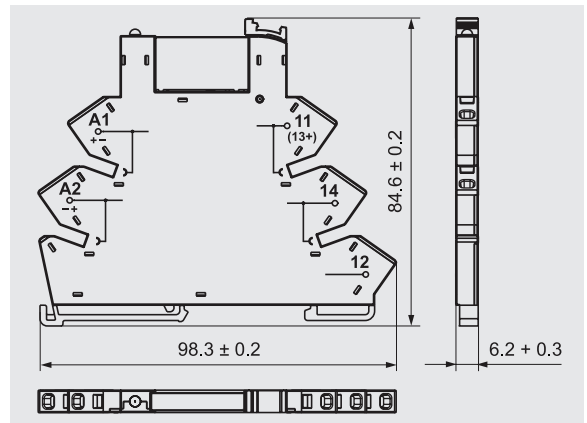

PI6WB-1PS-...



RM699BV



RSR30

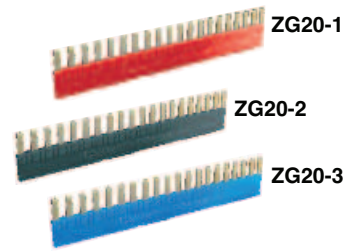

ZG20-1

ZG20-2

ZG20-3



PI6W-1246



Green LED:
signalling the operation status of the relay.

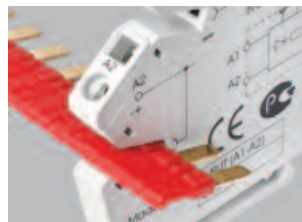

Interconnection strip ZG20:
bridging of common input or output signals.



Movable ejector: protection and easy replacement of the operational relay.

All accessories are sold separately.

PIR6WB-1PS

Subminiature Electromagnetic and Solid State Modules

Electromagnetic Relays

Featuring Electromagnetic relay RM699BV / 6A; 250VAC / 24VDC

Part Number	Rated input voltage U_N	Power of input circuit	Socket code	Operational relay code	Rated voltage of operational relay U_S
PIR6WB-1PS-6VDC-R	6 V DC	0.3 W	PI6WB-1PS-6VDC	RM699BV-3011-85-1005	5 V DC
PIR6WB-1PS-12VDC-R	12 V DC	0.2 W	PI6WB-1PS-12/24VDC	RM699BV-3011-85-1012	12 V DC
► PIR6WB-1PS-24VDC-R	24 V DC	0.3 W	PI6WB-1PS-12/24VDC	RM699BV-3011-85-1024	24 V DC
PIR6WB-1PS-36VDC-R	36 V DC	0.3 W	PI6WB-1PS-36VDC	RM699BV-3011-85-1024	24 V DC
PIR6WB-1PS-48VDC-R	48 V DC	0.4 W	PI6WB-1PS-48VDC	RM699BV-3011-85-1024	24 V DC
PIR6WB-1PS-60VDC-R	60 V DC	0.5 W	PI6WB-1PS-60VDC	RM699BV-3011-85-1024	24 V DC
► PIR6WB-1PS-24VAC/DC-R	24 V AC/DC	0.5 VA / 0.4 W	PI6WB-1PS-24VAC/DC	RM699BV-3011-85-1012	12 V DC
PIR6WB-1PS-42VAC/DC-R	42 V AC/DC	0.5 VA / 0.4 W	PI6WB-1PS-42VAC/DC	RM699BV-3011-85-1024	24 V DC
► PIR6WB-1PS-115VAC/DC-R	115 V AC/DC	1.2 VA / 1.2 W	PI6WB-1PS-115VAC/DC	RM699BV-3011-85-1024	24 V DC
PIR6WB-1PS-230VAC/DC-R	230 V AC/DC	1.2 VA / 1.2 W	PI6WB-1PS-230VAC/DC	RM699BV-3011-85-1048	48 V DC

Featuring Electromagnetic relay RM699BV / 0.05A; 30VAC / 36VDC. gold plated contacts

Part Number	Rated input voltage U_N	Power of input circuit	Socket code	Operational relay code	Rated voltage of operational relay U_S
PIR6WB-1PS-6VDC-R01	6 V DC	0.3 W	PI6WB-1PS-6VDC	RM699BV-3011-85-1005	5 V DC
PIR6WB-1PS-12VDC-R01	12 V DC	0.2 W	PI6WB-1PS-12/24VDC	RM699BV-3011-85-1012	12 V DC
PIR6WB-1PS-24VDC-R01	24 V DC	0.3 W	PI6WB-1PS-12/24VDC	RM699BV-3011-85-1024	24 V DC
PIR6WB-1PS-36VDC-R01	36 V DC	0.3 W	PI6WB-1PS-36VDC	RM699BV-3011-85-1024	24 V DC
PIR6WB-1PS-48VDC-R01	48 V DC	0.4 W	PI6WB-1PS-48VDC	RM699BV-3011-85-1024	24 V DC
PIR6WB-1PS-60VDC-R01	60 V DC	0.5 W	PI6WB-1PS-60VDC	RM699BV-3011-85-1024	24 V DC
► PIR6WB-1PS-24VAC/DC-R01	24 V AC/DC	0.5 VA / 0.4 W	PI6WB-1PS-24VAC/DC	RM699BV-3011-85-1012	12 V DC
PIR6WB-1PS-42VAC/DC-R01	42 V AC/DC	0.5 VA / 0.4 W	PI6WB-1PS-42VAC/DC	RM699BV-3011-85-1024	24 V DC
PIR6WB-1PS-115VAC/DC-R01	115 V AC/DC	1.2 VA / 1.2 W	PI6WB-1PS-115VAC/DC	RM699BV-3011-85-1024	24 V DC
PIR6WB-1PS-230VAC/DC-R01	230 V AC/DC	1.2 VA / 1.2 W	PI6WB-1PS-230VAC/DC	RM699BV-3011-85-1048	48 V DC

The rated input voltage of the operational relay U_S not always complies with the rated input voltage U_N (which is important on ordering operational relays for sockets). For versions of the input voltage $U_N = 230$ V AC/DC keep the distance between the mounting relays min. 5 mm under maximum load and at continuous operation.

Altech Custom Assemblies

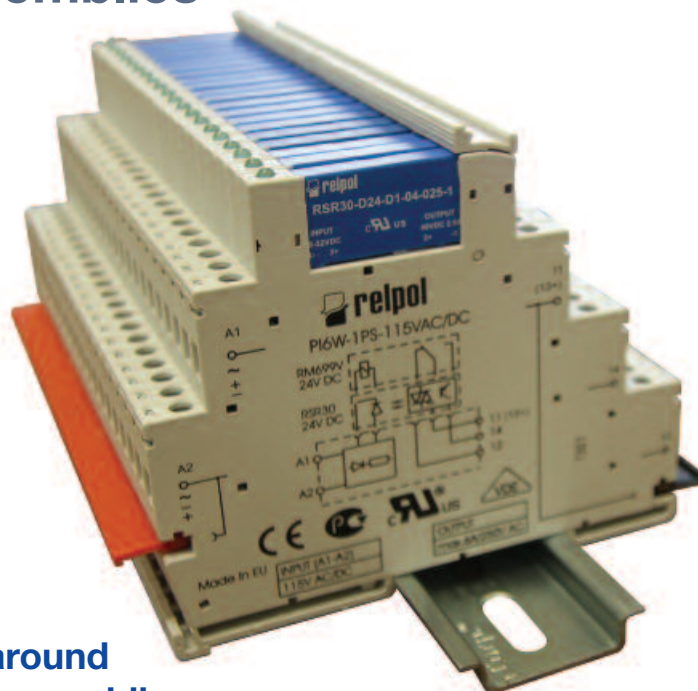

Altech provides quick turnaround and competitive prices on assemblies.

For complete assemblies contact Altech.

► BOLD - Regular stocked items.

Solid State Relays

Featuring Solid State Triac (T) relay RSR30 / 2A; 240VAC output

Part Number	Rated input voltage U_N	Power of input circuit	Socket code	Operational relay code	Rated voltage of operational relay U_S
PIR6WB-1PS-6VDC-T	6 V DC	0.2 W	PI6WB-1PS-6VDC	RSR30-D05-A1-24-020-1	5 V DC
PIR6WB-1PS-12VDC-T	12 V DC	0.2 W	PI6WB-1PS-12/24VDC	RSR30-D12-A1-24-020-1	12 V DC
PIR6WB-1PS-24VDC-T	24 V DC	0.3 W	PI6WB-1PS-12/24VDC	RSR30-D24-A1-24-020-1	24 V DC
PIR6WB-1PS-36VDC-T	36 V DC	0.3 W	PI6WB-1PS-36VDC	RSR30-D24-A1-24-020-1	24 V DC
PIR6WB-1PS-48VDC-T	48 V DC	0.4 W	PI6WB-1PS-48VDC	RSR30-D24-A1-24-020-1	24 V DC
PIR6WB-1PS-60VDC-T	60 V DC	0.5 W	PI6WB-1PS-60VDC	RSR30-D24-A1-24-020-1	24 V DC
► PIR6WB-1PS-24VAC/DC-T	24 V AC/DC	0.5 VA / 0.4 W	PI6WB-1PS-24VAC/DC	RSR30-D12-A1-24-020-1	12 V DC
PIR6WB-1PS-42VAC/DC-T	42 V AC/DC	0.5 VA / 0.4 W	PI6WB-1PS-42VAC/DC	RSR30-D24-A1-24-020-1	24 V DC
PIR6WB-1PS-115VAC/DC-T	115 V AC/DC	1.0 VA / 1.0 W	PI6WB-1PS-115VAC/DC	RSR30-D24-A1-24-020-1	24 V DC

Featuring Solid State transistor (C) relay RSR30 / 1A; 48VDC output

Part Number	Rated input voltage U_N	Power of input circuit	Socket code	Operational relay code	Rated voltage of operational relay U_S
PIR6WB-1PS-6VDC-C	6 V DC	0.2 W	PI6WB-1PS-6VDC	RSR30-D05-D1-04-025-1	5 V DC
PIR6WB-1PS-12VDC-C	12 V DC	0.2 W	PI6WB-1PS-12/24VDC	RSR30-D12-D1-04-025-1	12 V DC
PIR6WB-1PS-24VDC-C	24 V DC	0.3 W	PI6WB-1PS-12/24VDC	RSR30-D24-D1-04-025-1	24 V DC
PIR6WB-1PS-36VDC-C	36 V DC	0.3 W	PI6WB-1PS-36VDC	RSR30-D24-D1-04-025-1	24 V DC
PIR6WB-1PS-48VDC-C	48 V DC	0.4 W	PI6WB-1PS-48VDC	RSR30-D24-D1-04-025-1	24 V DC
PIR6WB-1PS-60VDC-C	60 V DC	0.5 W	PI6WB-1PS-60VDC	RSR30-D24-D1-04-025-1	24 V DC
► PIR6WB-1PS-24VAC/DC-C	24 V AC/DC	0.5 VA / 0.4 W	PI6WB-1PS-24VAC/DC	RSR30-D12-D1-04-025-1	12 V DC
PIR6WB-1PS-42VAC/DC-C	42 V AC/DC	0.5 VA / 0.4 W	PI6WB-1PS-42VAC/DC	RSR30-D24-D1-04-025-1	24 V DC
PIR6WB-1PS-115VAC/DC-C	115 V AC/DC	1.0 VA / 1.0 W	PI6WB-1PS-115VAC/DC	RSR30-D24-D1-04-025-1	24 V DC
PIR6WB-1PS-230VAC/DC-C	230 V AC/DC	1.0 VA / 1.0 W	PI6WB-1PS-230VAC/DC	RSR30-D48-D1-04-025-1	48 V DC

Featuring Solid State transistor (O) relay RSR30 / 2A; 24VDC output

Part Number	Rated input voltage U_N	Power of input circuit	Socket code	Operational relay code	Rated voltage of operational relay U_S
PIR6WB-1PS-6VDC-O	6 V DC	0.2 W	PI6WB-1PS-6VDC	RSR30-D05-D1-02-040-1	5 V DC
PIR6WB-1PS-12VDC-O	12 V DC	0.2 W	PI6WB-1PS-12/24VDC	RSR30-D12-D1-02-040-1	12 V DC
PIR6WB-1PS-24VDC-O	24 V DC	0.3 W	PI6WB-1PS-12/24VDC	RSR30-D24-D1-02-040-1	24 V DC
PIR6WB-1PS-36VDC-O	36 V DC	0.3 W	PI6WB-1PS-36VDC	RSR30-D24-D1-02-040-1	24 V DC
PIR6WB-1PS-48VDC-O	48 V DC	0.4 W	PI6WB-1PS-48VDC	RSR30-D24-D1-02-040-1	24 V DC
PIR6WB-1PS-60VDC-O	60 V DC	0.5 W	PI6WB-1PS-60VDC	RSR30-D24-D1-02-040-1	24 V DC
► PIR6WB-1PS-24VAC/DC-O	24 V AC/DC	0.5 VA / 0.4 W	PI6WB-1PS-24VAC/DC	RSR30-D12-D1-02-040-1	12 V DC
PIR6WB-1PS-42VAC/DC-O	42 V AC/DC	0.5 VA / 0.4 W	PI6WB-1PS-42VAC/DC	RSR30-D24-D1-02-040-1	24 V DC
PIR6WB-1PS-115VAC/DC-O	115 V AC/DC	1.0 VA / 1.0 W	PI6WB-1PS-115VAC/DC	RSR30-D24-D1-02-040-1	24 V DC
PIR6WB-1PS-230VAC/DC-O	230 V AC/DC	1.0 VA / 1.0 W	PI6WB-1PS-230VAC/DC	RSR30-D48-D1-02-040-1	48 V DC

It should be noted that the rated input voltage of the operational relay (U_S) is not always the same as the rated input voltage of the relay and socket combination (U_N) (This is important when ordering operational relays for sockets). For versions of the input voltage $U_N = 230$ V AC/DC keep the distance between the mounting relays min. 5 mm under maximum load and at continuous operation.

► **BOLD** - Regular stocked items.